

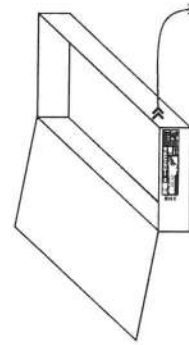

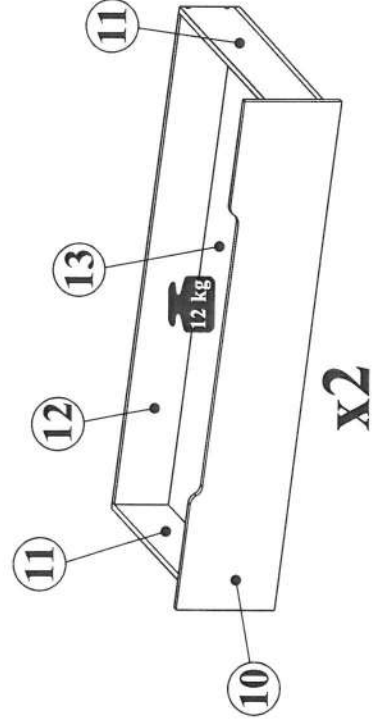

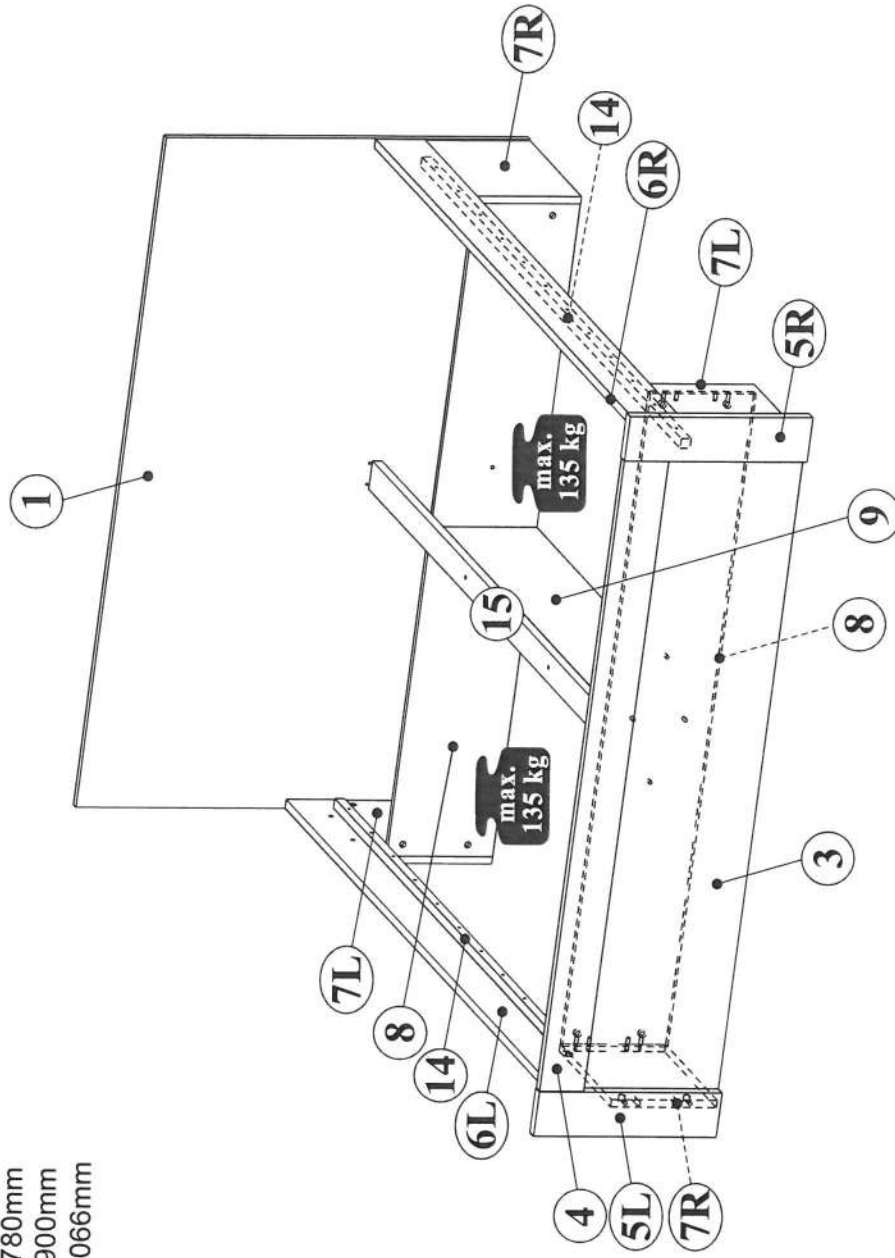

B - 1780mm  
 H - 900mm  
 T - 2066mm

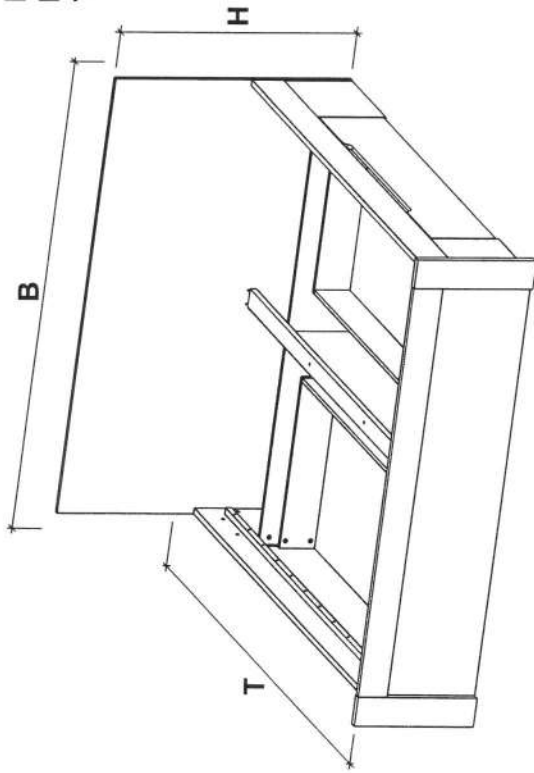





1	1656x900	1	2/3
3	1609x381	1	2/3
4	1560x110	1	2/3
5L,5R	452x110	2	2/3
6L,6R	2020x121	2	1/3
7L,7R	377x261	4	1/3
8	1614x261	2	1/3
9	1267x260	1	1/3
10	1258x245	2	3/3
11	650x134	4	3/3
12	1211x134	2	3/3
13	1241x650	2	3/3
14	1900x24	2	1/3
15	1987x70	1	1/3



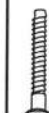



**NR 1**

<b>B24</b>  φ 10x50 x8
<b>B20</b>  φ 8x50 x4
<b>B1</b>  φ 8x28 x32
<b>M1</b>  φ15x12mm x28
<b>T1</b>  5x39mm x28

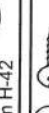



**NR 2**

<b>K7</b>  7x70 x8
<b>K1</b>  7x50 x8
<b>K9</b>  7x35 x8
<b>G7</b>  S4 x1

**NR 3**

<b>J4</b>  φ35mm H=42 x8
<b>E3</b>  6,3x13 x8
<b>S8</b>  4x13 x8
<b>I8</b>  x8
<b>P43</b>  x16
<b>F12</b>  x6
<b>P13</b>  3,5x13 x24
<b>P5</b>  4x30 x34

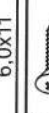
**NR 4**

<b>F8</b>  x2
<b>F9</b>  x2
<b>E24</b>  6,0x11 x8
<b>S9</b>  4x16 x6
<b>S14</b>  4x40 x26

C 1/3



## 1

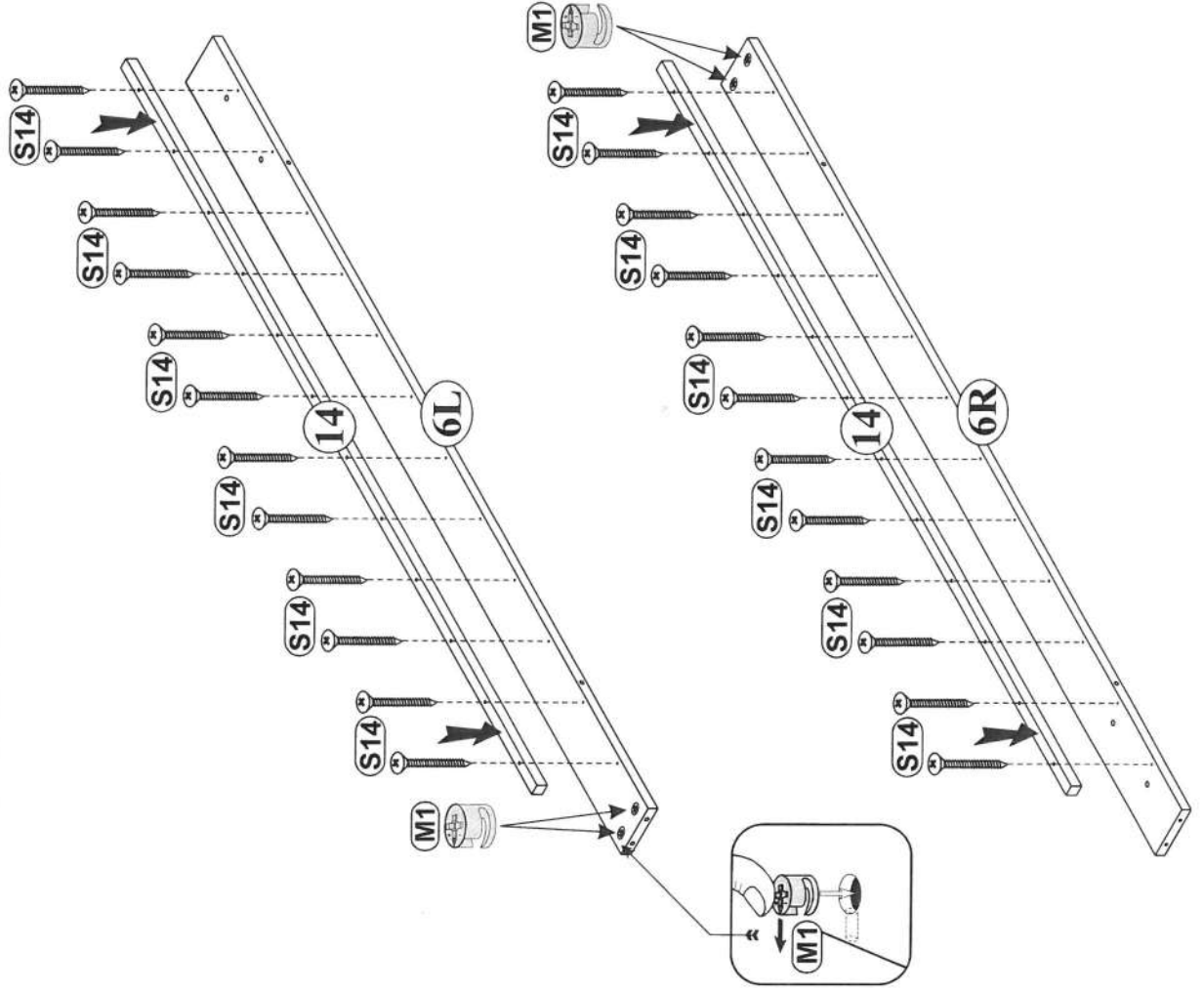
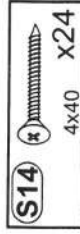

## 2

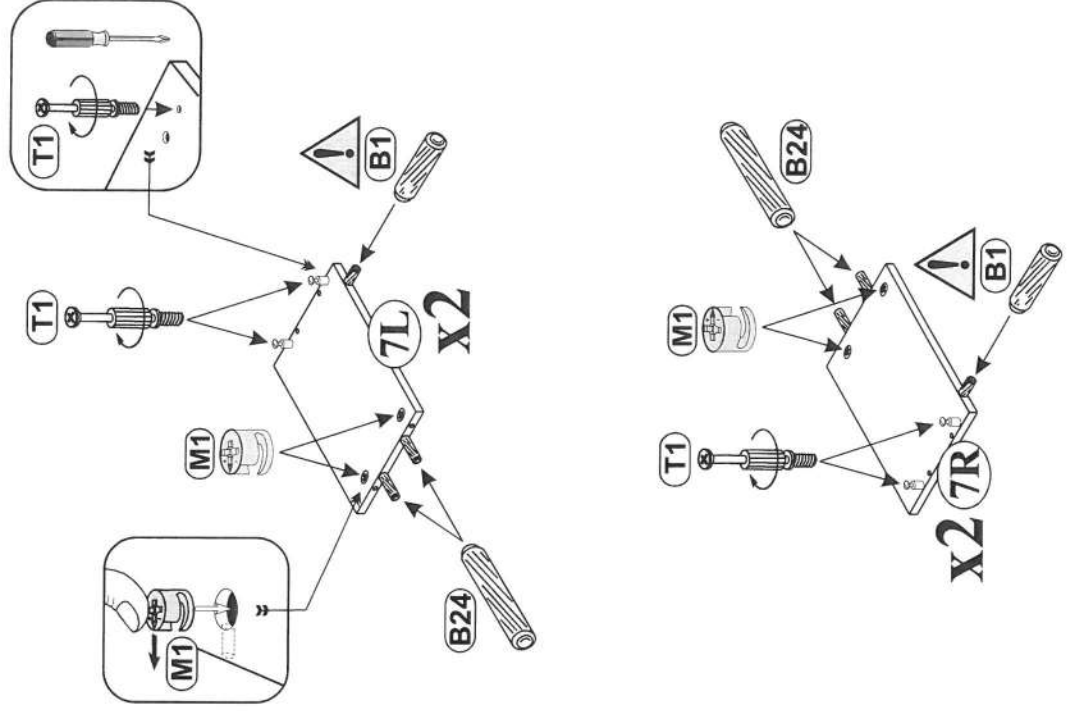
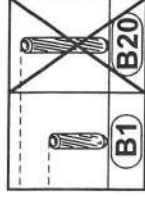
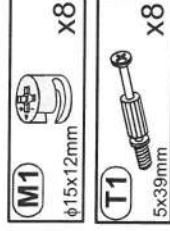
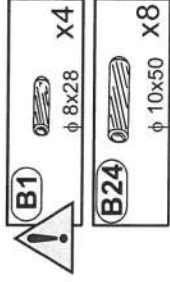

**3**

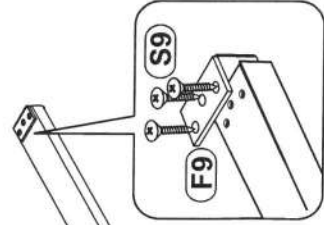
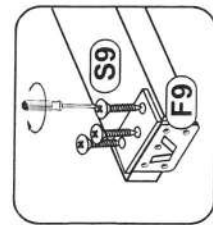
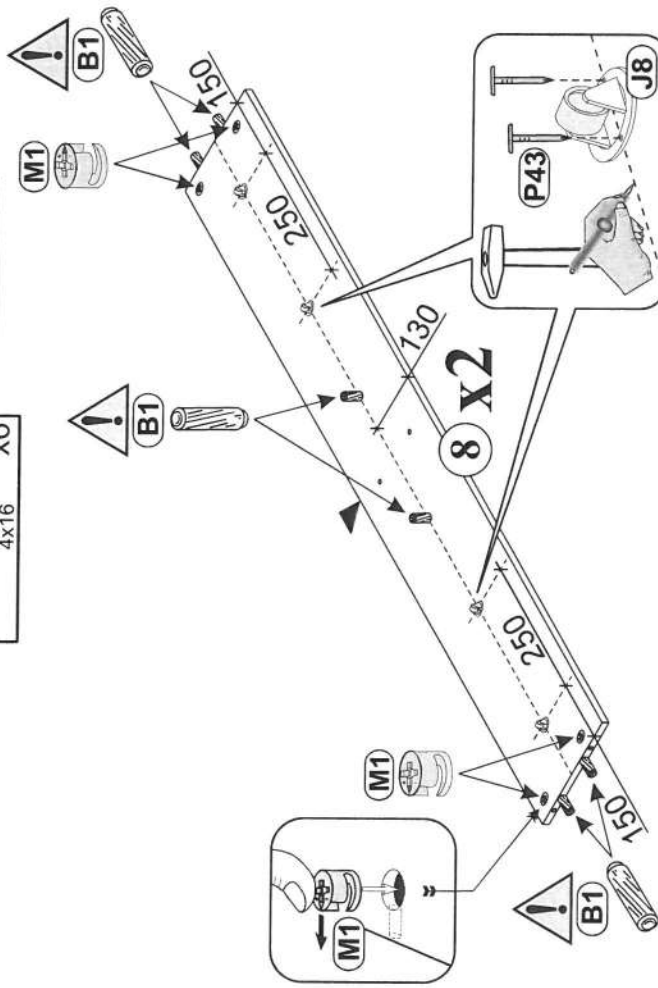
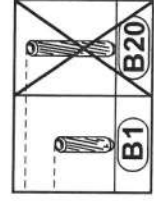
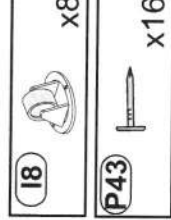
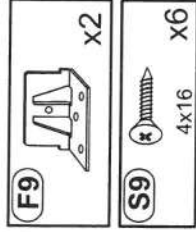
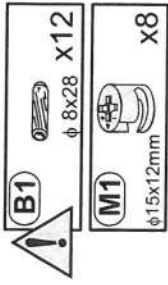

**4**

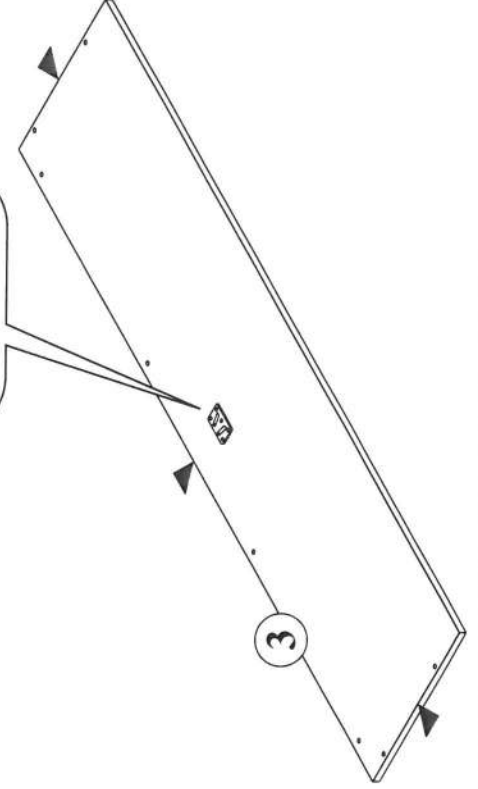
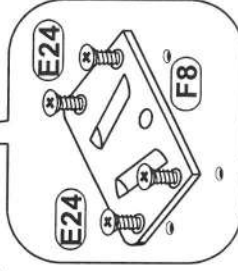
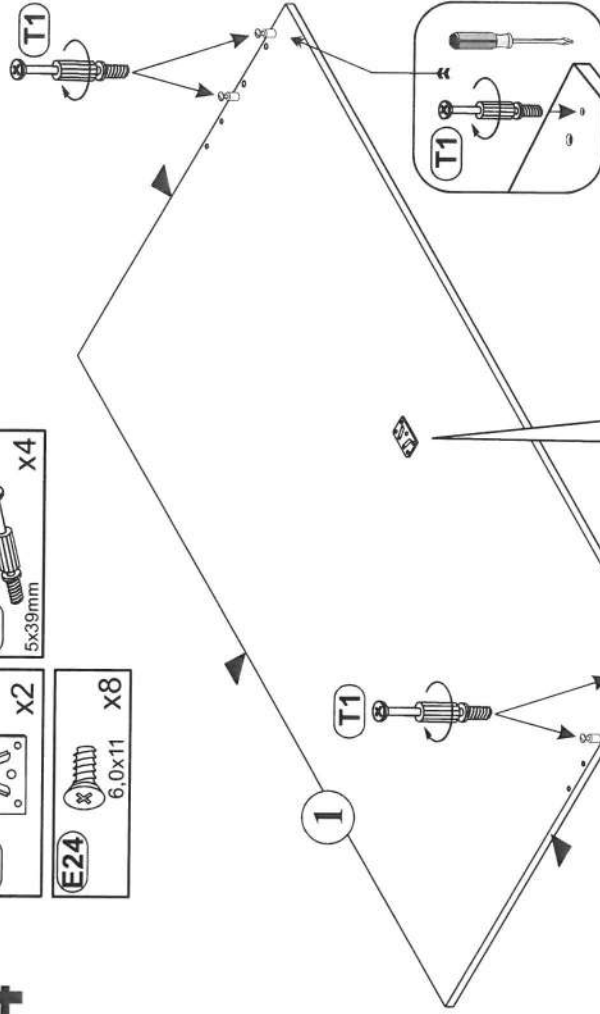
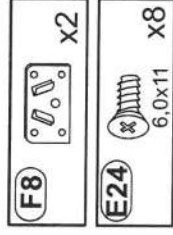

**3**

**8 x 2**

**15**

5

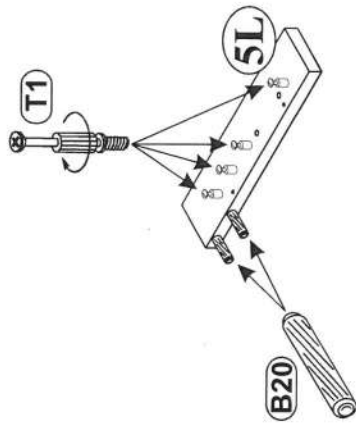
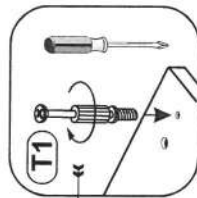
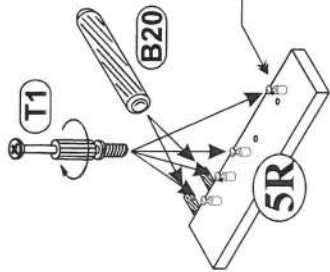
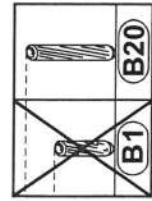

6

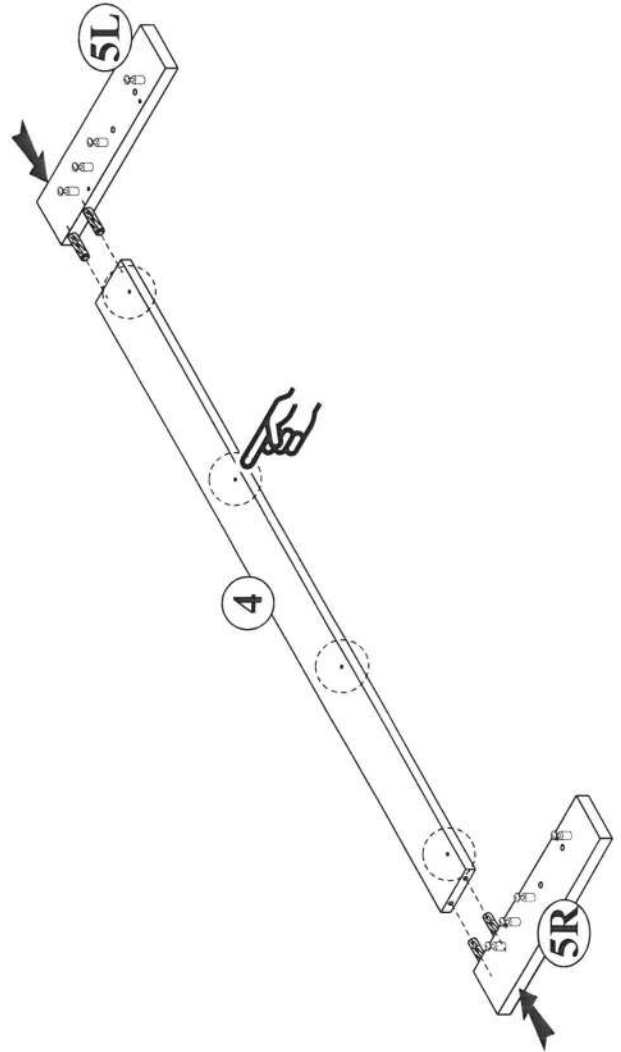
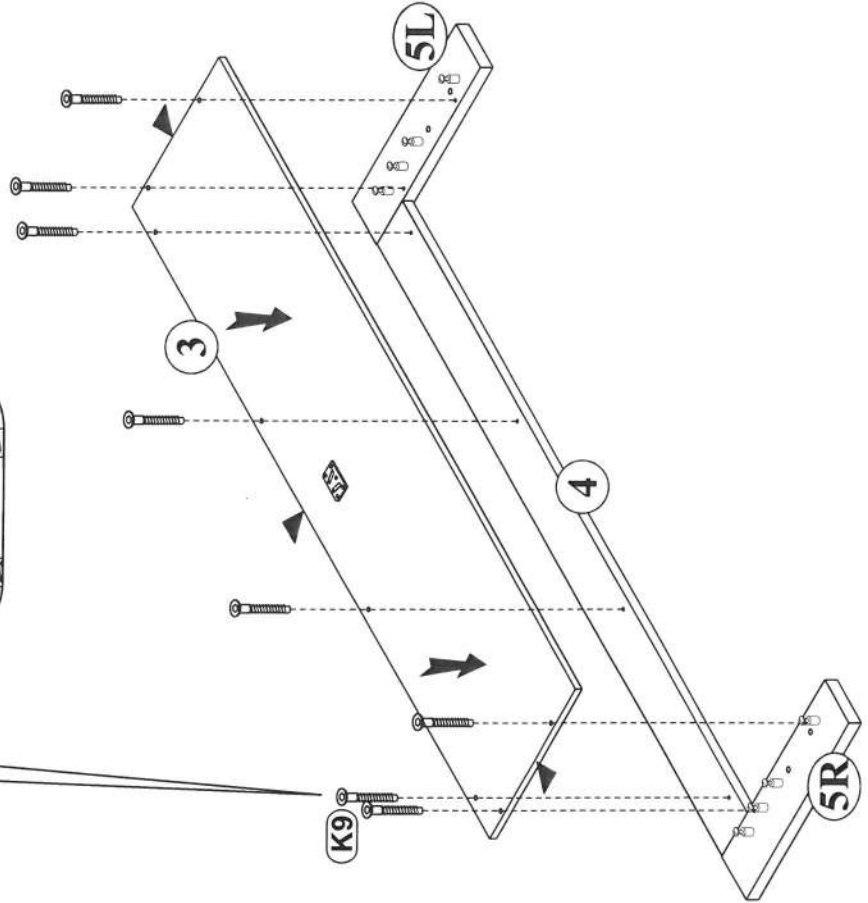
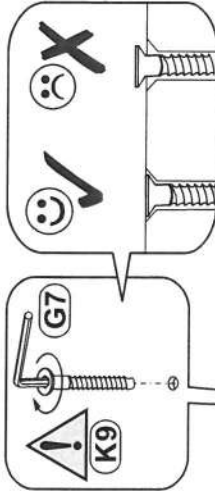

7

- T1 5x39mm x8
- B1  $\phi$  8x28 x8
- M1  $\phi$ 15x12mm x8

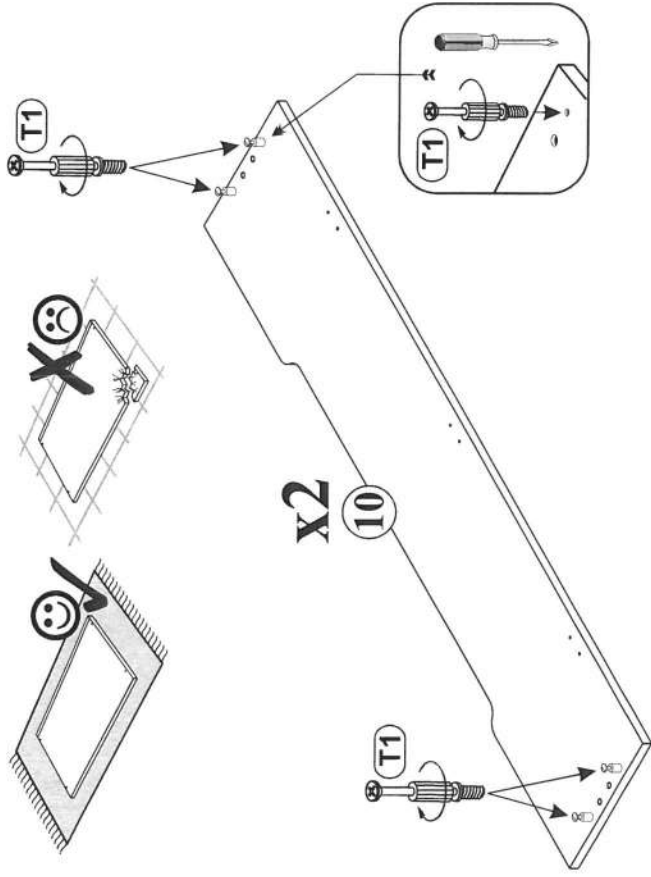

8

- J4  $\phi$ 35mm H-42 x8
- E3 6,3x13 x8
- S8 4x13 x8
- F12 x6
- P13 3,5x13 x12
- B1  $\phi$  8x28 x8

x2

12

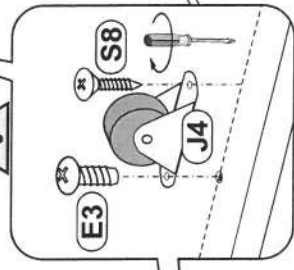
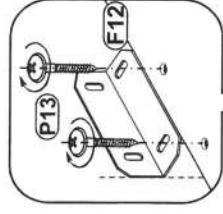
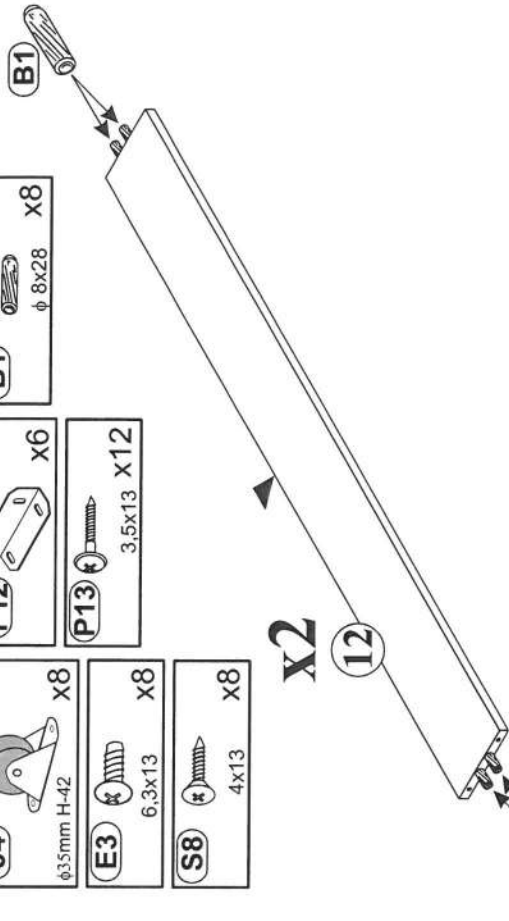

x2

13

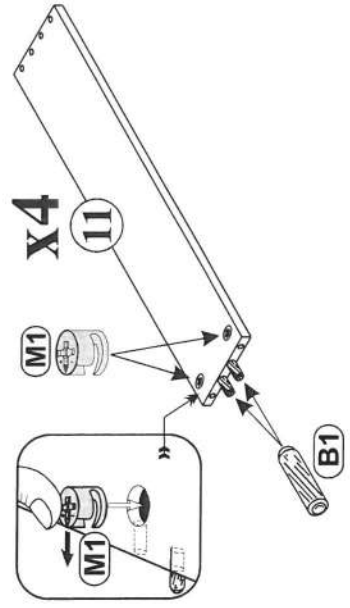

x4

11

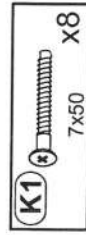

**9**

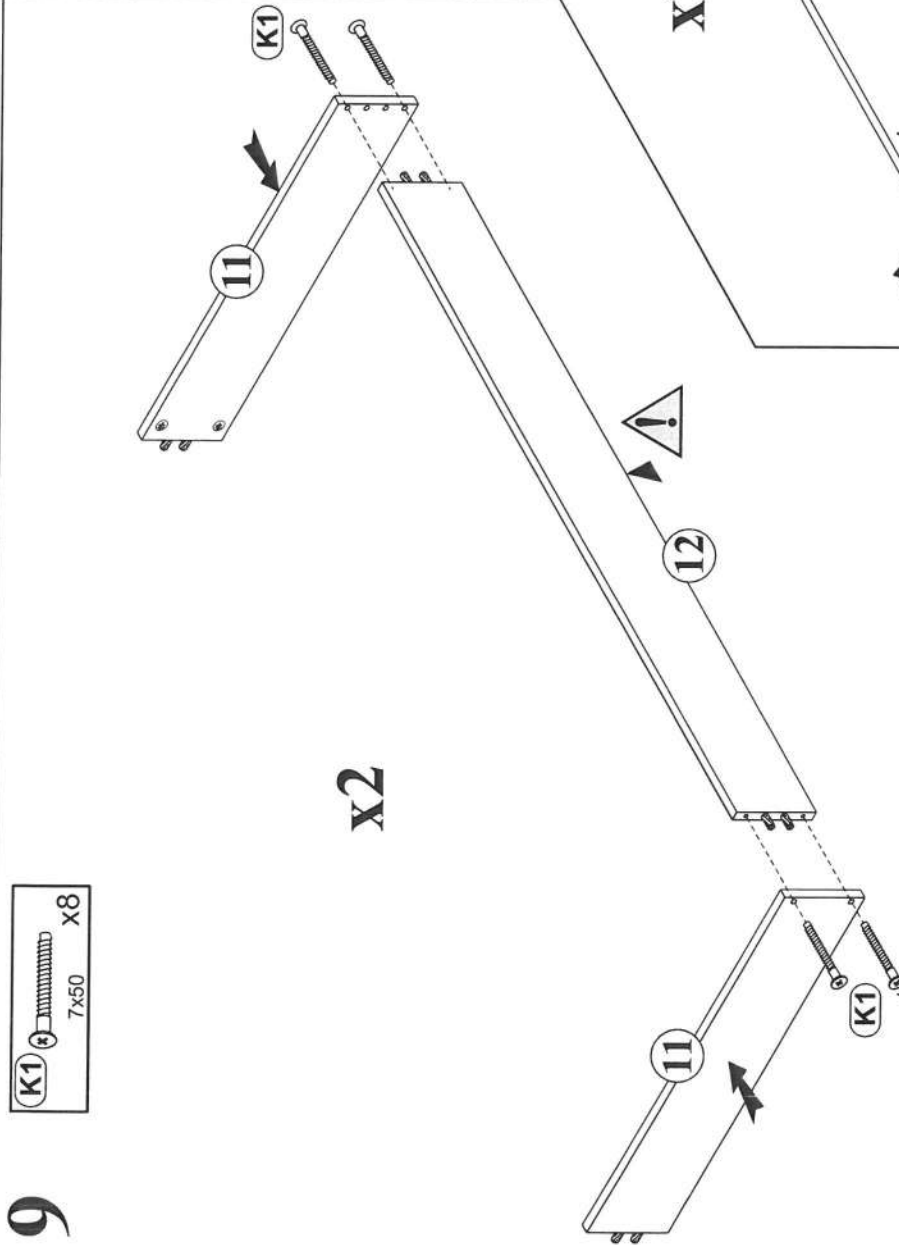

**10**

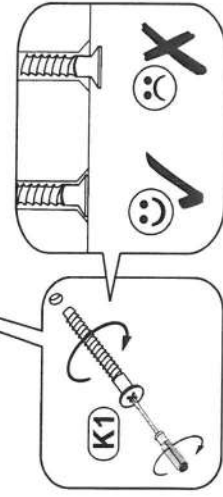
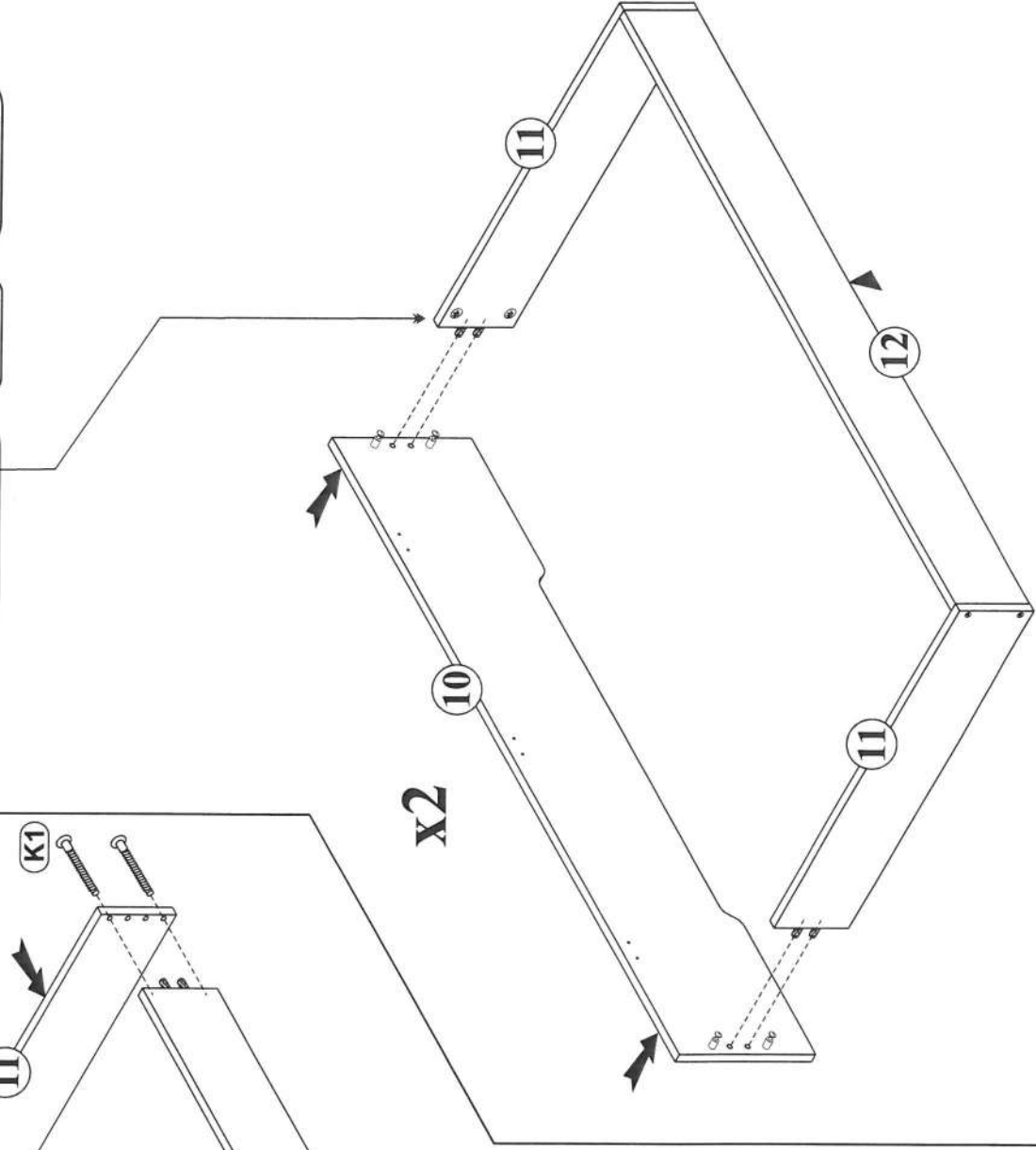
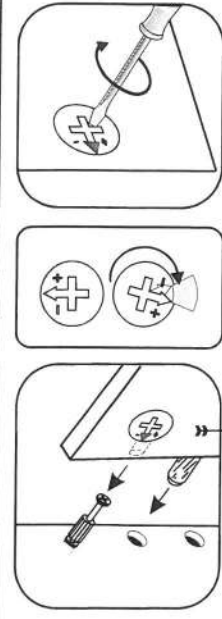



11

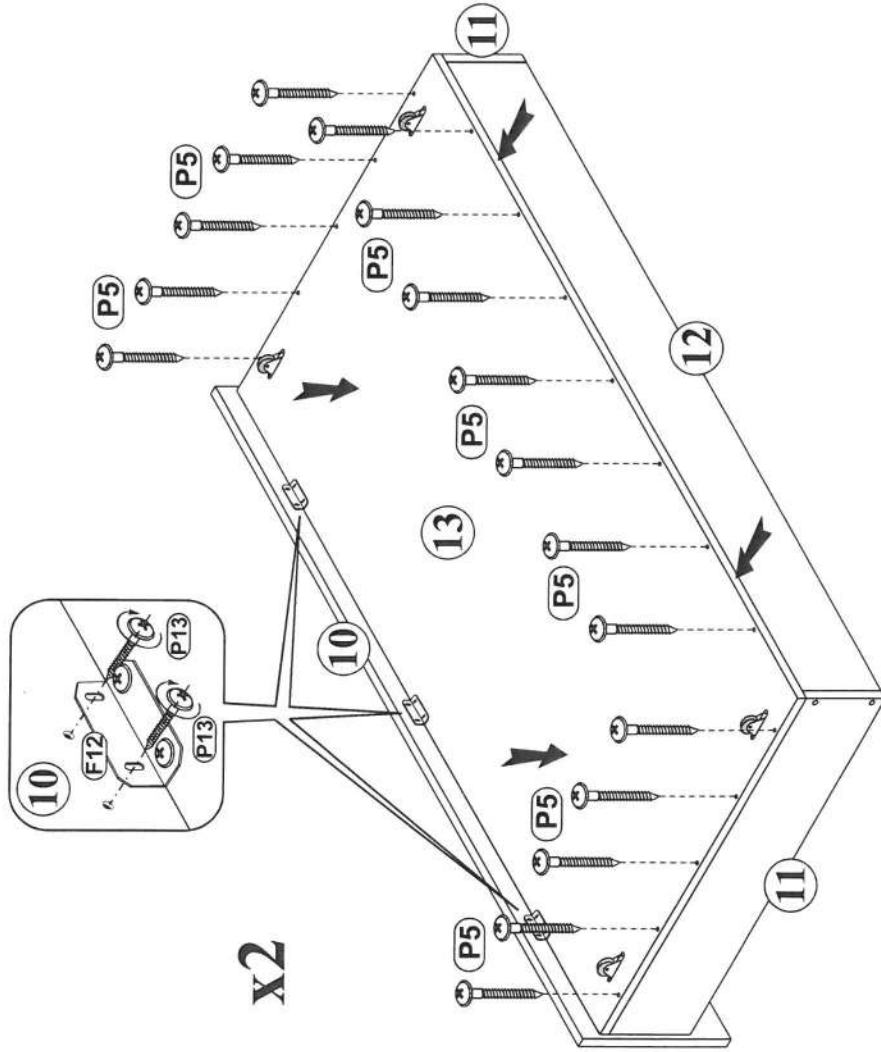

12

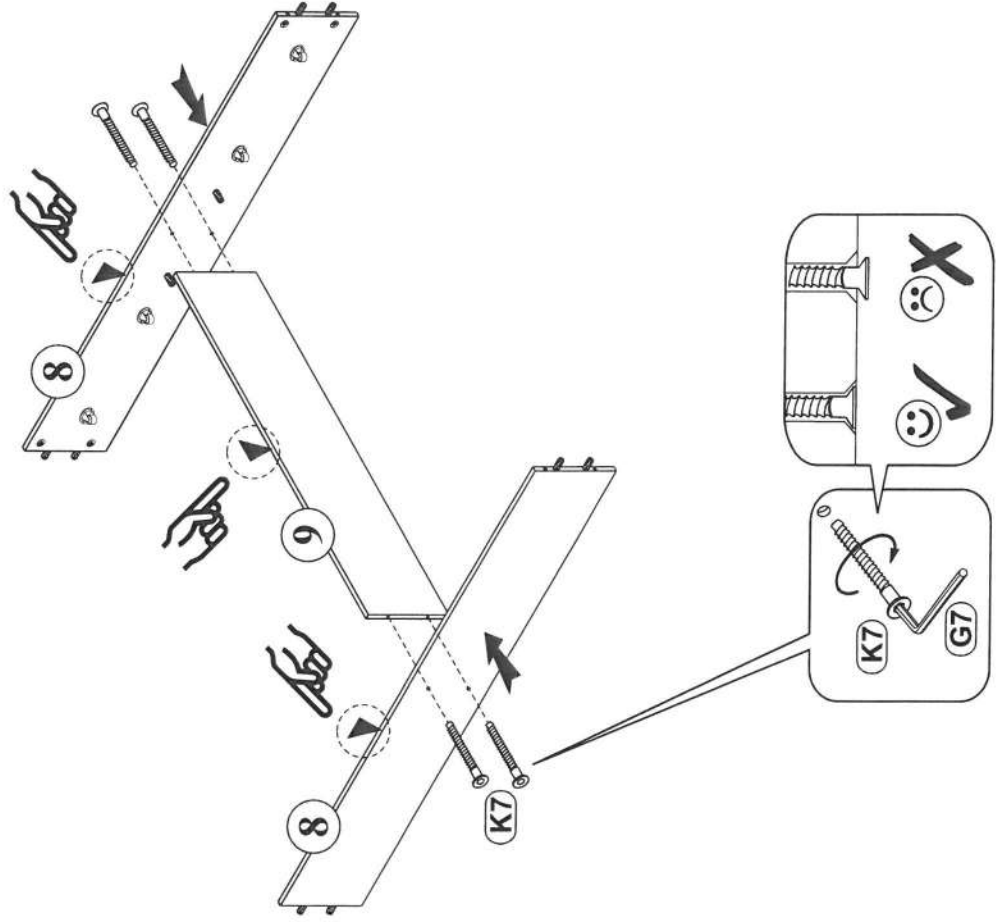
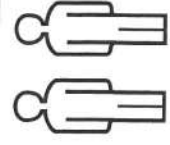

13

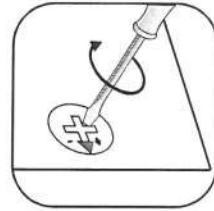
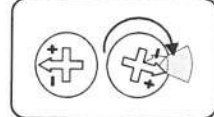

14

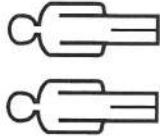

Icon of two people, indicating that two people are required for this step.

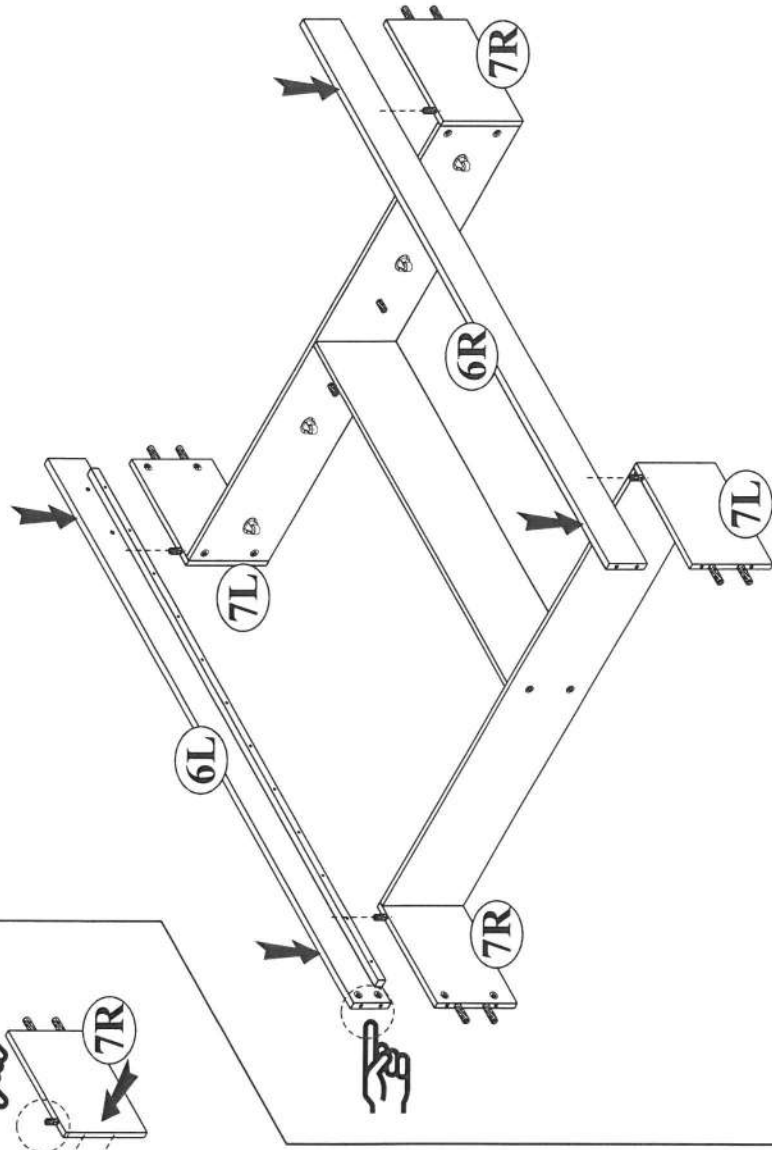
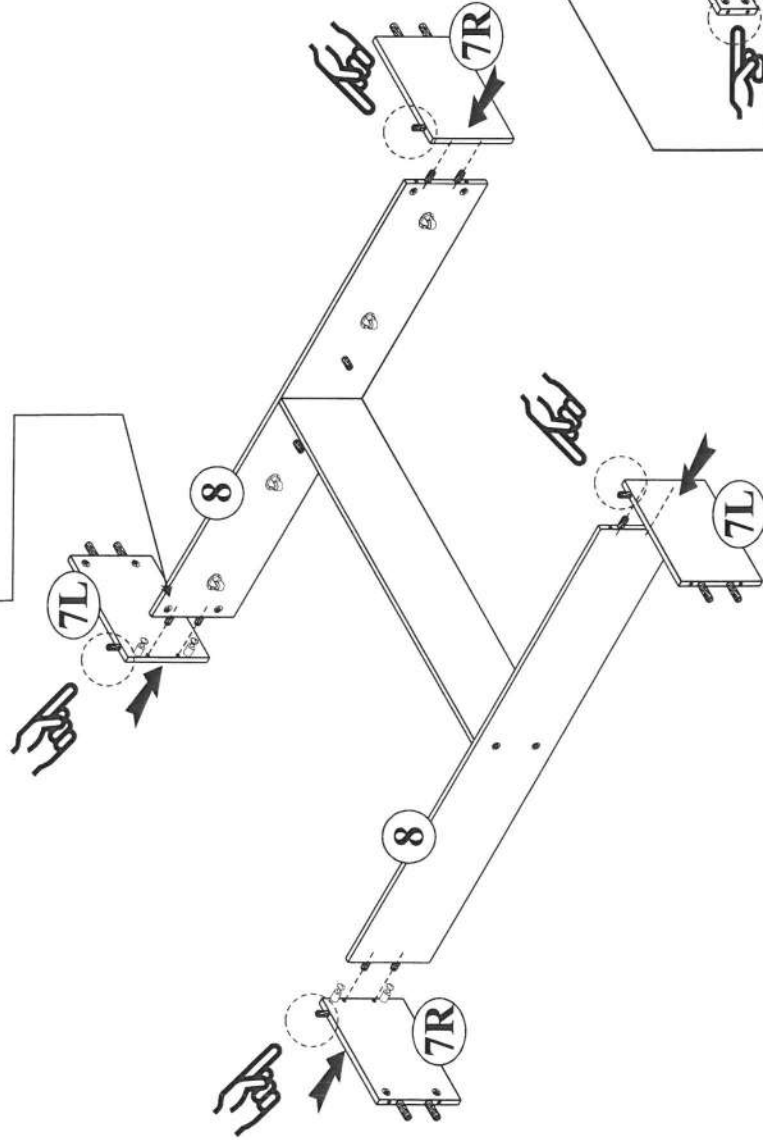

15

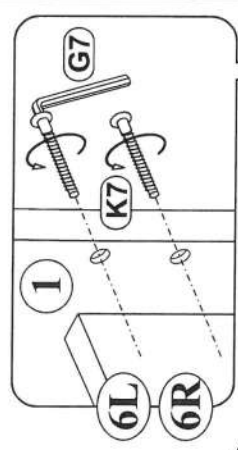
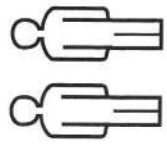

16

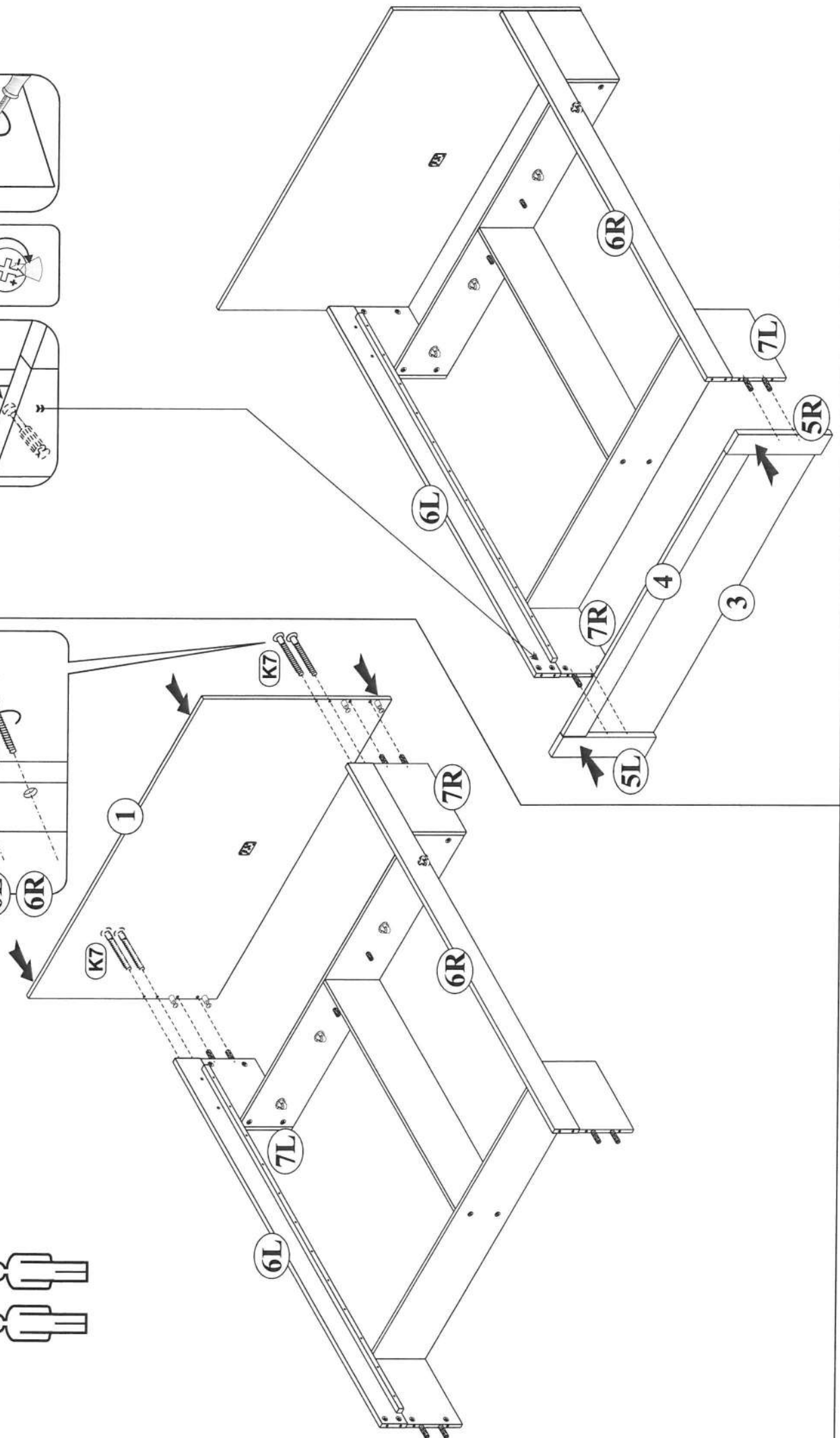
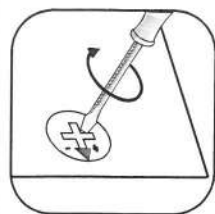
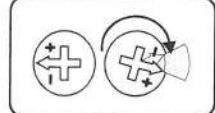
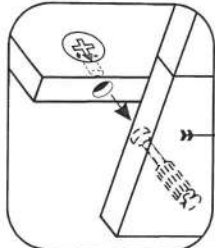

17

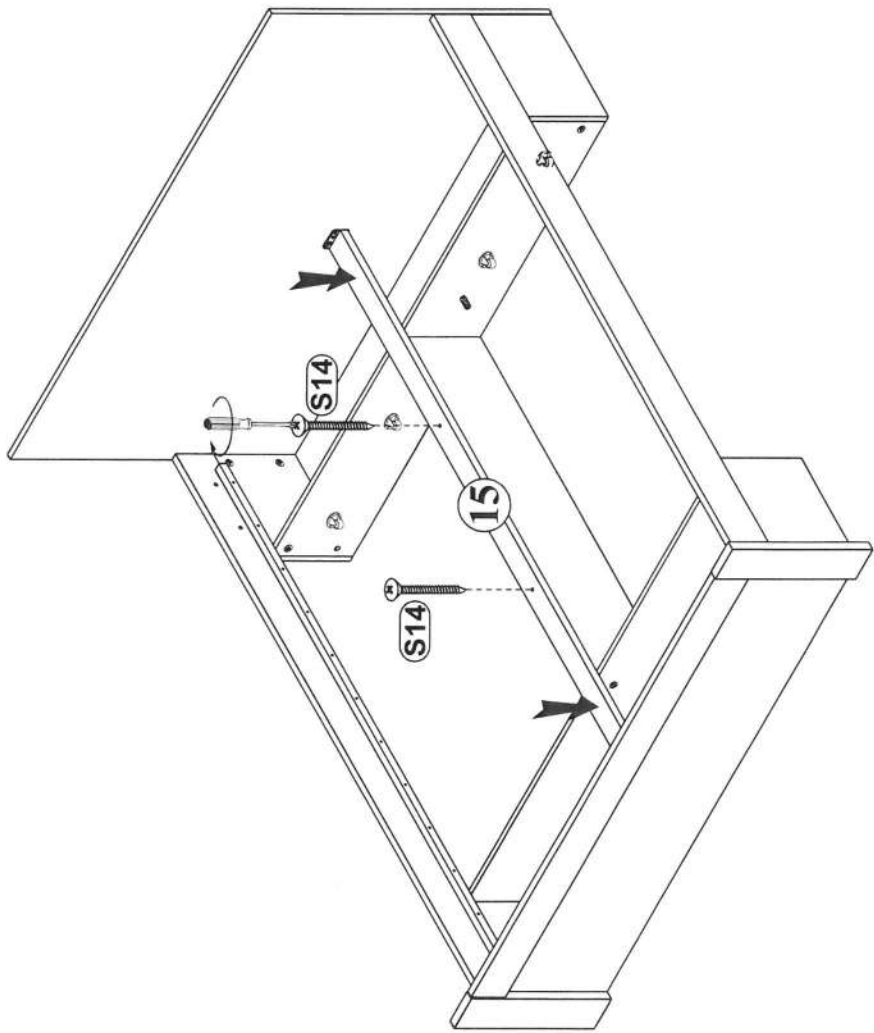
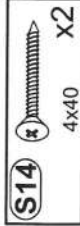

18

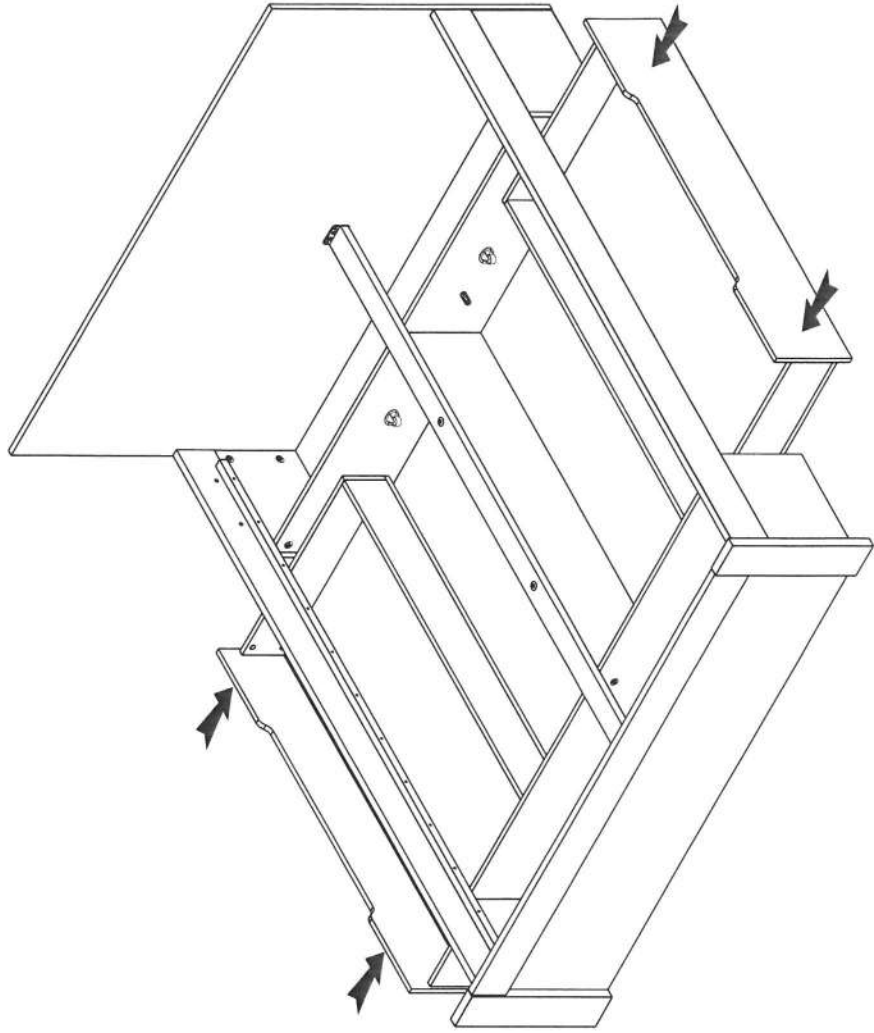

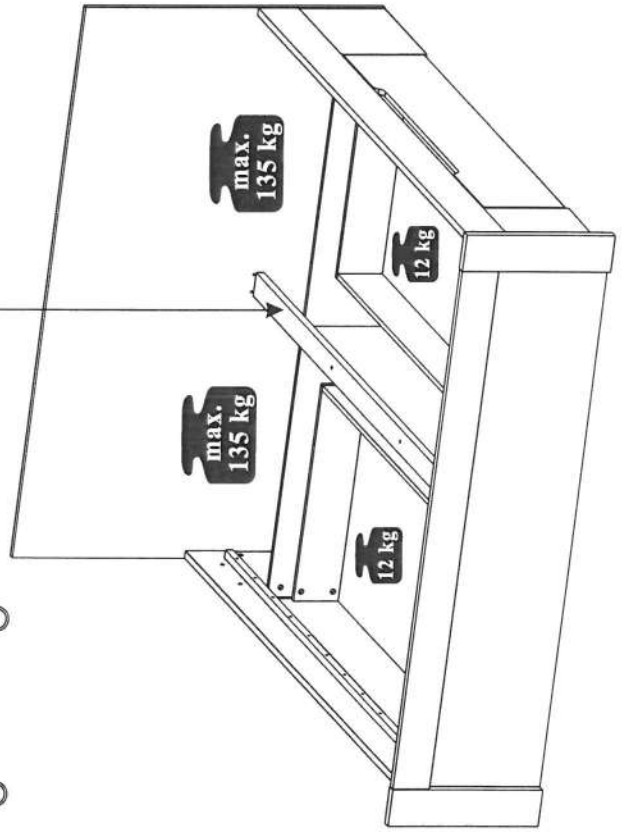
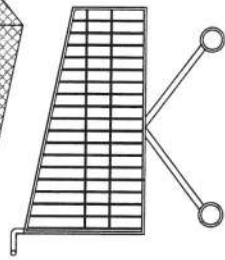
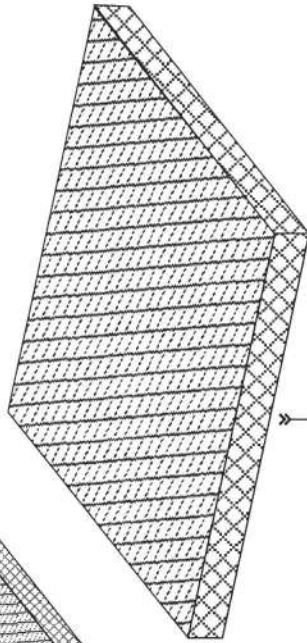
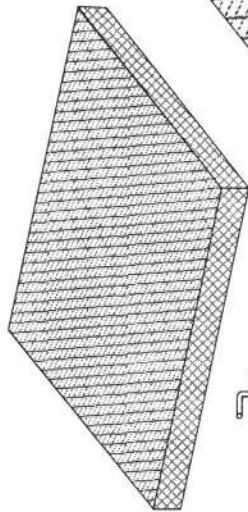

8X--AT 1L

8X--AT 1P

